

MODÈLE FAST-TOUCH

– BARRE DE PRESSION –

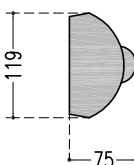

(*) MINIMAL DIMENSION 2^{ème} VANTAIL = 350 mm

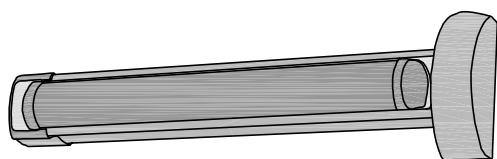
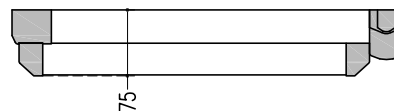
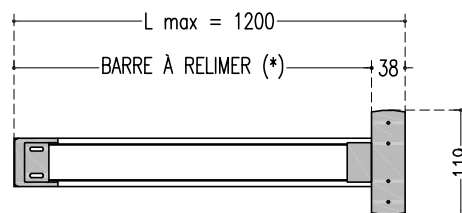

FONCTIONNEMENT

- De l'intérieur: pousser la barre
- De l'extérieur: avec clé et/ou poignée

MODÈLE TRADITIONNEL

– BARRE BASCULANTE –

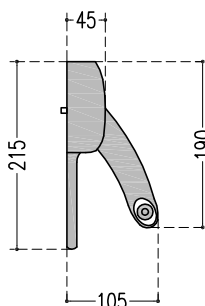
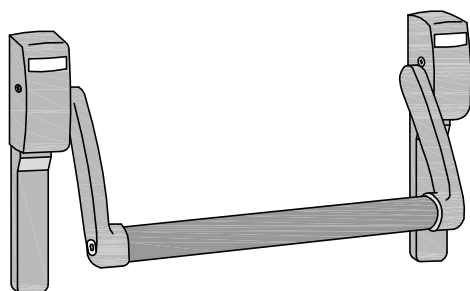

(*) MINIMAL DIMENSION 2^{ème} VANTAIL = 300 mm

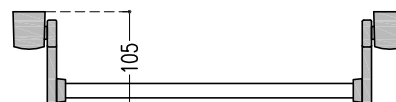
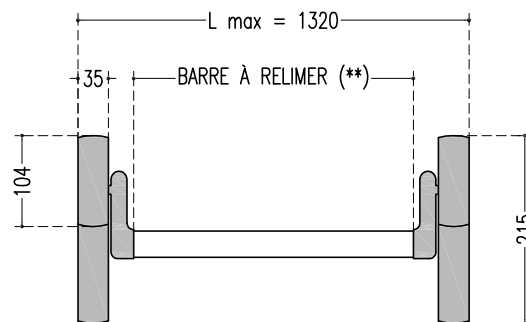

FONCTIONNEMENT

- De l'intérieur: pousser la barre
- De l'extérieur: avec clé et/ou poignée

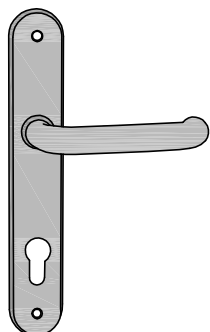

POIGNÉE SUR PLATE

– ½ POIGNÉE ASSORTIE À ASSEMBLER SUR CÔTÉ À TIRER –

G1

SEPTEMBRE 2017

**BARRE ANTIPANIQUE
BASCULANTE ET DE PRESSION**

DIMENSIONS



SEBINO CHIUSURE Srl
I - 24020 Scanzorosclate (BG)
Via XXV Aprile, 21
Tel. 035.24.27.10
Fax 035.24.47.37
www.sebinochiusure.it
Info@sebinochiusure.it