

PLANCHE SANS CADRE APPLIQUÉ

PLANCHE AVEC CADRE APPLIQUÉ

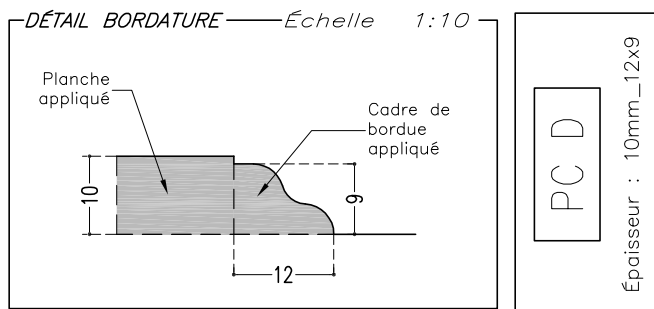
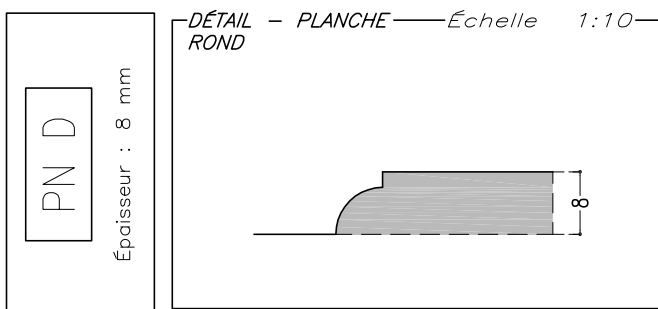
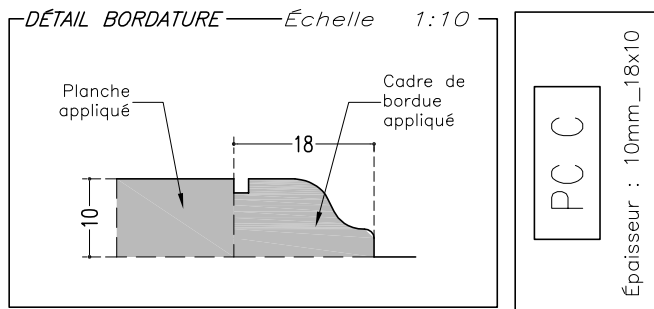
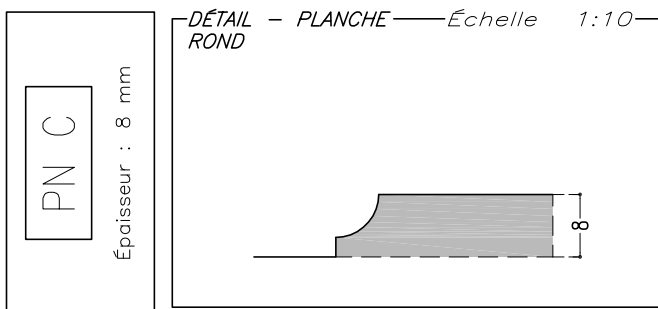
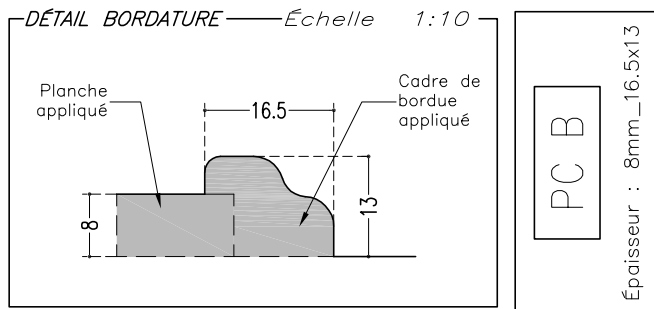
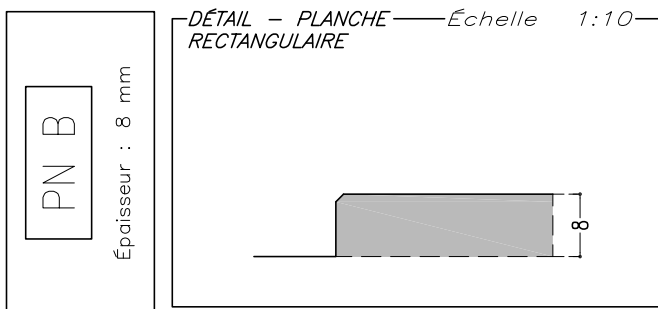
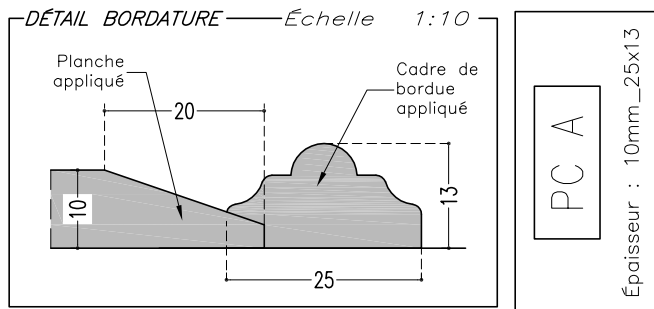
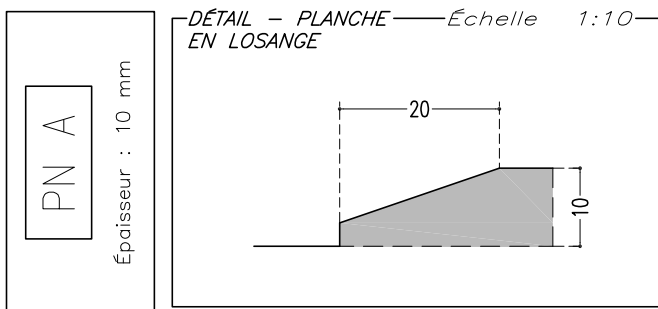

SEBINO CHIUSURE Srl
I - 24020 Scanzorosclate (BG)
Via XXV Aprile, 21
Tel. 035.24.27.10
Fax 035.24.47.37
www.sebinochiusure.it
Info@sebinochiusure.it

PORTES FAÇONNÉES
- PLANCHE APPLIQUÉS -

DIMENSIONS ET TYPOLOGIES

SEPTEMBRE 2017

H2